

# nienkämper

257 Finchdene Square  
Scarborough, Ontario,  
Canada M1X 1B9  
Tel | 1-800-668-9318  
EMAIL- mail@nienkamper.com  
www.nienkamper.com

MODEL - DUO BASES  
SIZE: 216" X 60"

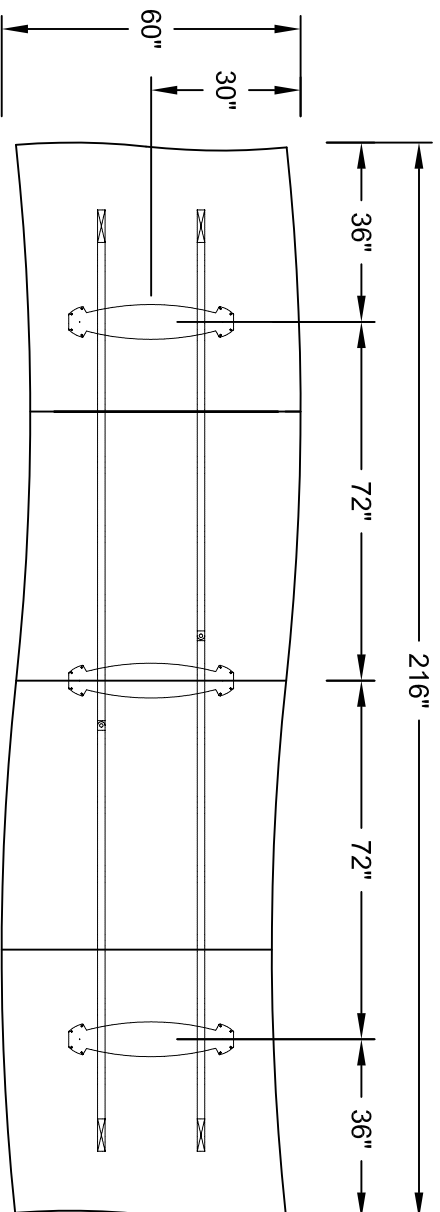

PLAN VIEW

DIMENSIONS SHOWN TO CENTRE OF BASES

THIS DRAWING IS CONFIDENTIAL AND PROPRIETARY. NO PART OF THIS DRAWING  
MAY BE COPIED, DISCLOSED TO ANY THIRD PARTY OR USED FOR ANY PURPOSE  
WITHOUT THE EXPRESS WRITTEN AUTHORIZATION OF NIENKAMPER FURNITURE & ACCESSORIES

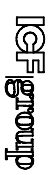

# nienkämper

257 Finchdene Square  
Scarborough, Ontario,  
Canada M1X 1B9  
Tel | 1-800-668-9318  
EMAIL- mail@nienkamper.com  
www.nienkamper.com

MODEL - TAPER AND T-BASES  
SIZE: 216" X 60"

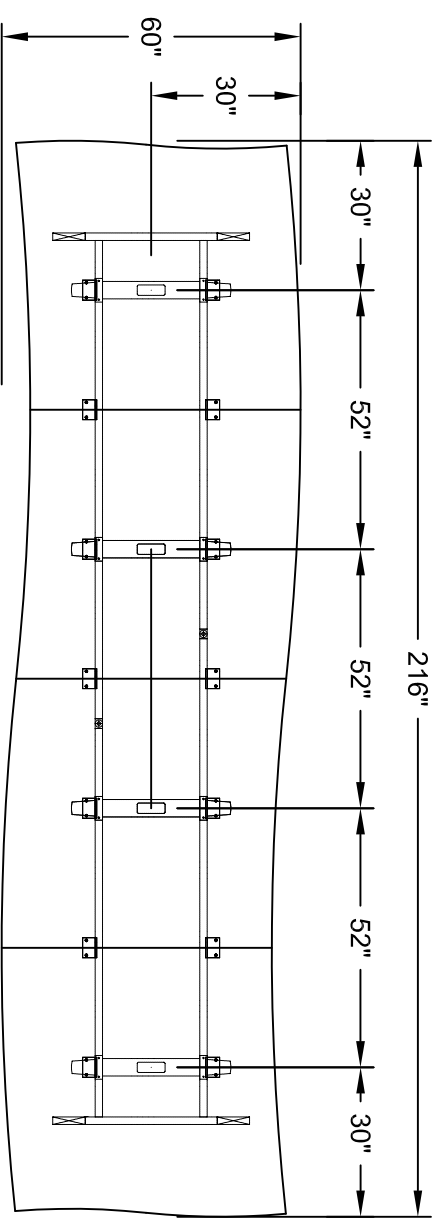

PLAN VIEW

DIMENSIONS SHOWN TO CENTRE OF BASES

THIS DRAWING IS CONFIDENTIAL AND PROPRIETARY. NO PART OF THIS DRAWING  
MAY BE COPIED, DISCLOSED TO ANY THIRD PARTY OR USED FOR ANY PURPOSE  
WITHOUT THE EXPRESS WRITTEN AUTHORIZATION OF NIENKAMPER FURNITURE & ACCESSORIES