

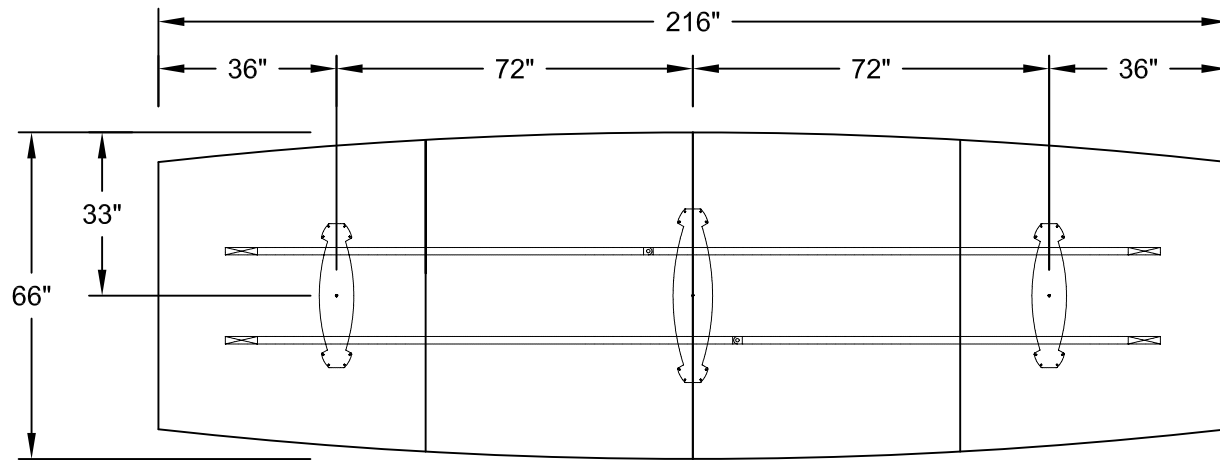

nienkämper

257 Finchdene Square
Scarborough, Ontario,
Canada M1X 1B9
Tel 1-800-668-9318
EMAIL- mail@nienkamper.com
www.nienkamper.com

MODEL - DUO BASES
SIZE: 216" X 66"



PLAN VIEW

DIMENSIONS SHOWN TO CENTRE OF BASES

THIS DRAWING IS CONFIDENTIAL AND PROPRIETARY. NO PART OF THIS DRAWING
MAY BE COPIED, DISCLOSED TO ANY THIRD PARTY OR USED FOR ANY PURPOSE
WITHOUT THE EXPRESS WRITTEN AUTHORIZATION OF NIENKAMPER FURNITURE & ACCESSORIES



nienkämper

257 Finchdene Square
Scarborough, Ontario,
Canada M1X 1B9
Tel 1-800-668-9318
EMAIL- mail@nienkamper.com
www.nienkamper.com

MODEL - TAPER AND T-BASES
SIZE: 216" X 66"

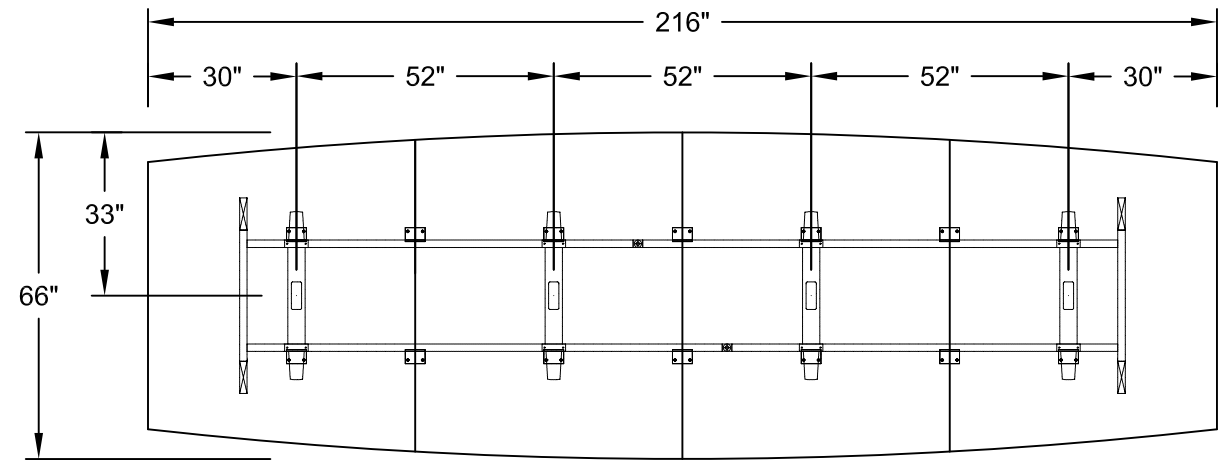

PLAN VIEW

DIMENSIONS SHOWN TO CENTRE OF BASES

THIS DRAWING IS CONFIDENTIAL AND PROPRIETARY. NO PART OF THIS DRAWING
MAY BE COPIED, DISCLOSED TO ANY THIRD PARTY OR USED FOR ANY PURPOSE
WITHOUT THE EXPRESS WRITTEN AUTHORIZATION OF NIENKAMPER FURNITURE & ACCESSORIES